

For professional use only. Please refer to the conditions of use of our catalogue.

April 2002

4TGL25 100x200R code T10-18

Voltage	Frequency	Input power	Current	Capacitor	Air flow	Rotational speed	Sound level	Direction of rotation	Max. Air temp.
V	Hz	Wa	A	μF	m ³ /h	rpm	dBA	↻	°C
230	50	43	0,22	1,5	380	1385	51	R	-20 / +60
230	60	54	0,27	1,5	442	1600	55	R	-20 / +60

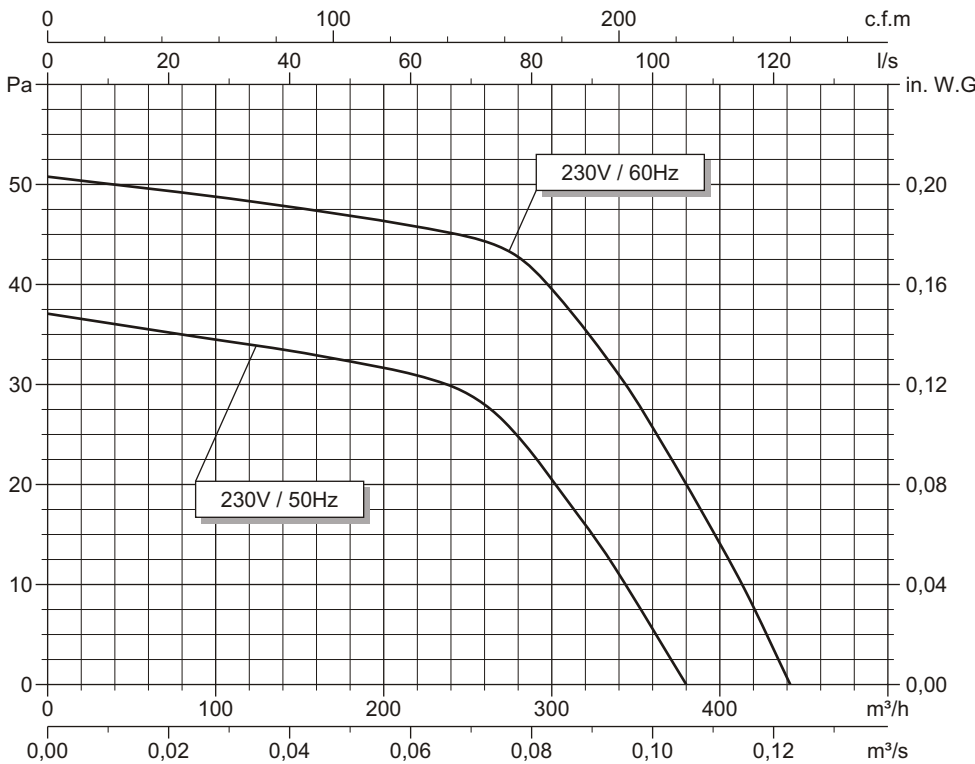
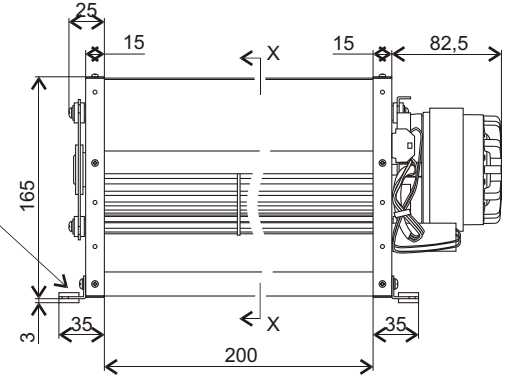
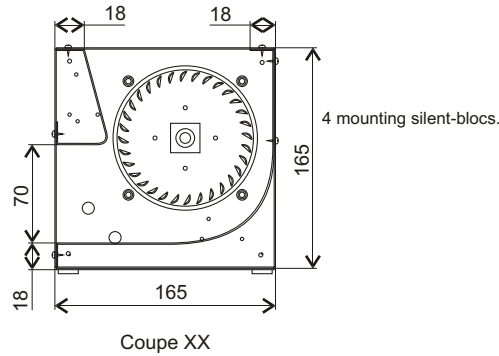
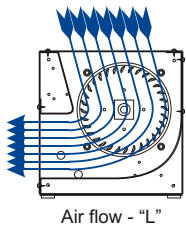
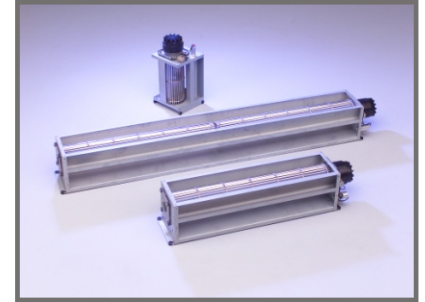

- Ball bearings.
- Cl.F windings protected by thermal cut-out.
- Protection IP 20.
- Balancing G2.5.
- Scroll housing in zinc coated sheet steel.
- Impeller in aluminium.
- Capacitor fixed on the scroll and connected to a WAGO Connector.

