

For professional use only. Please refer to the conditions of use of our catalogue.

April 2002

4TGS35 100x600R code T10-19

Voltage	Frequency	Input power	Current	Capacitor	Air flow	Rotational speed	Sound level	Direction of rotation	Max. Air temp.
V	Hz	Wa	A	µF	m ³ /h	rpm	dBA	↻	°C
230	50	80	0,37	2,5	870	1315	51	R	-20 / +60
230	60	92	0,41	2,5	990	1485	54	R	-20 / +60

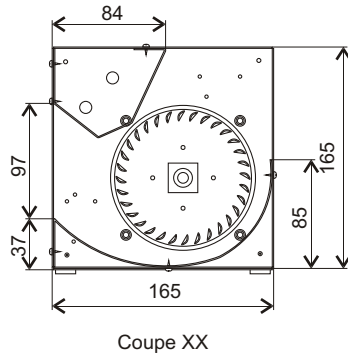
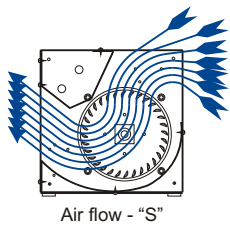
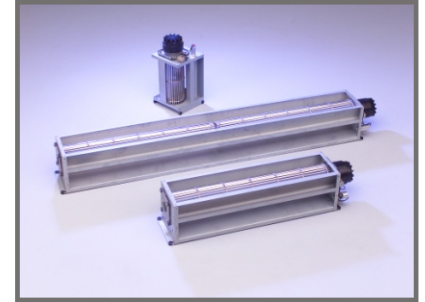

4 mounting silent-blocs.

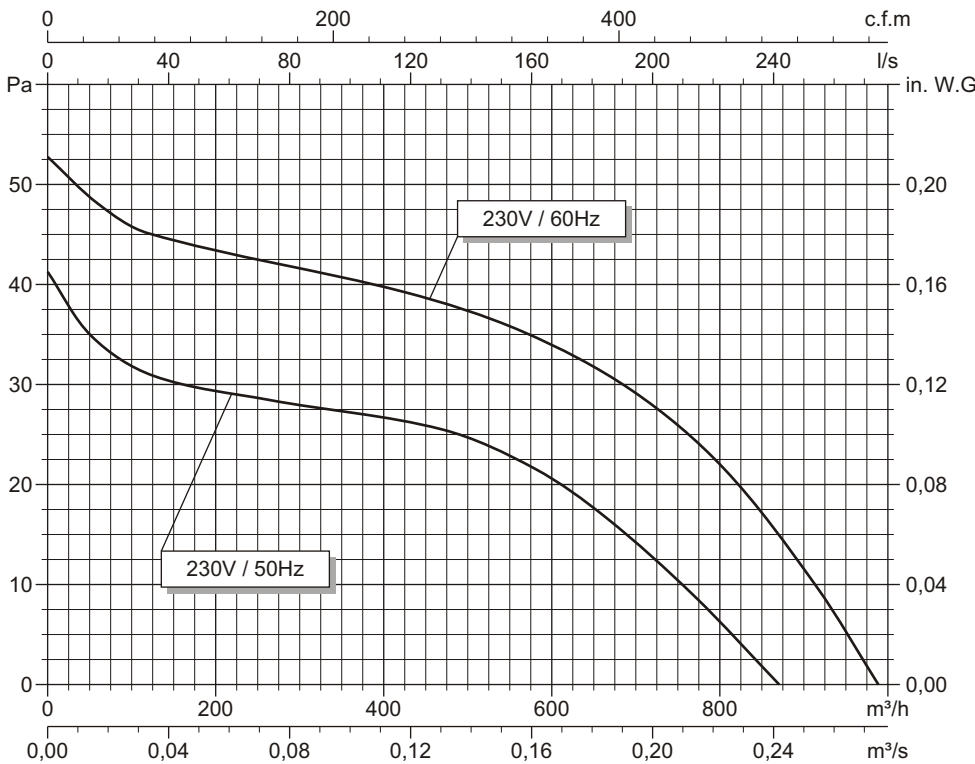
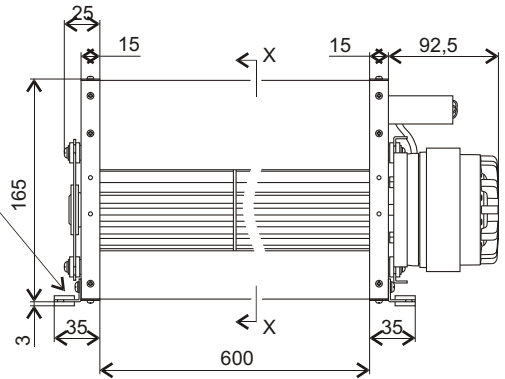

- Ball bearings.
- Cl.F windings protected by thermal cut-out.
- Protection IP 20.
- Balancing G2.5.
- Scroll housing in zinc coated sheet steel.
- Impeller in aluminium.
- Capacitor fixed on the scroll and connected to a WAGO Connector.

