

For professional use only. Please refer to the conditions of use of our catalogue.

April 2002

4TGS25 80x600R code Z21-33

Voltage	Frequency	Input power	Current	Capacitor	Air flow	Rotational speed	Sound level	Direction of rotation	Max. Air temp.
V	Hz	Wa	A	µF	m ³ /h	rpm	dBA	↻	°C
230	50	46	0,23	1,5	630	1365	56	R	-20 / +60
230	60	59	0,30	1,5	745	1560	59	R	-20 / +60

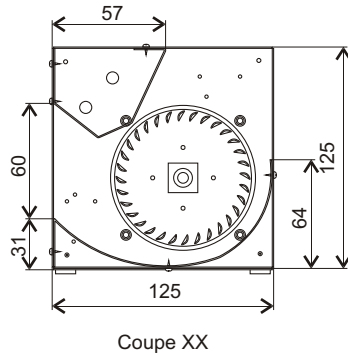
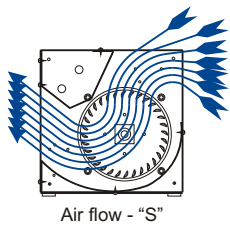
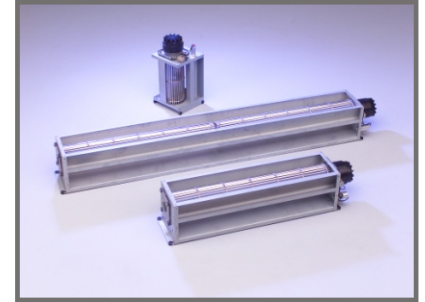

4 mounting silent-blocs.

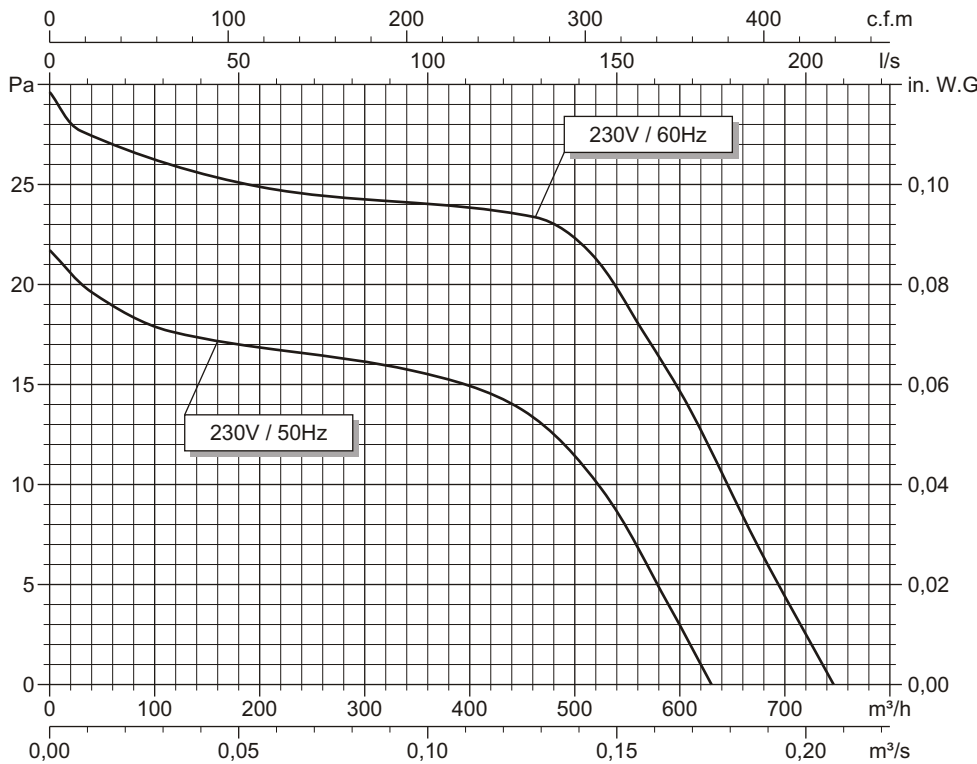
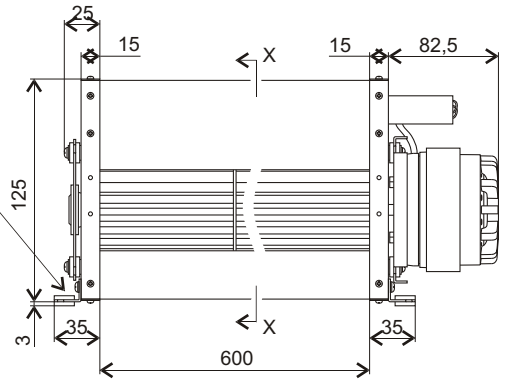

- Ball bearings.
- Cl.F windings protected by thermal cut-out.
- Protection IP 20.
- Balancing G2.5.
- Scroll housing in zinc coated sheet steel.
- Impeller in aluminium.
- Capacitor fixed on the scroll and connected to a WAGO Connector.

